

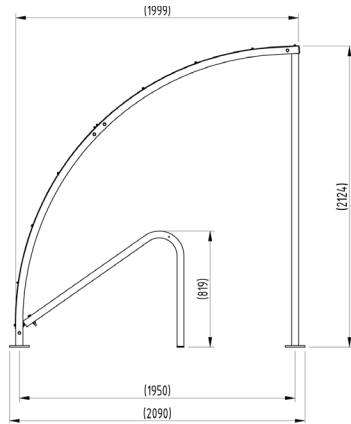

VS1 Shelter

Galvanised Steel Frame

No Sides - Galvanised Sheet



The VS1 Cycle Shelter is a light weight, free-standing, single sided cycle shelter with integrated cycle stands designed for on site assembly. Constructed from galvanised mild steel. Complete with galvanised sheet roof / back, with open ends.

Width of 2m, with lengths from 1m-5m, extension bays can be added to achieve the desired shelter length.

Bolt down as standard.

Uses

- | | | |
|---|--|---|
| <input checked="" type="checkbox"/> Cycle | <input type="checkbox"/> Waiting/Passenger | <input type="checkbox"/> Smoking/Vaping |
| <input type="checkbox"/> Trolley | <input type="checkbox"/> Walkway/Canopy | <input type="checkbox"/> Bin Store |
| <input type="checkbox"/> Sport & Spectators | <input type="checkbox"/> Pay & Display/E.V | <input type="checkbox"/> Youth |



Part Number	Description	Weight (kg)
138 200 340	VS1 Shelter 1m	88kg
138 200 341	VS1 Shelter 2m	143kg
138 200 342	VS1 Shelter 3m	205kg
138 200 343	VS1 Shelter 4m	260kg
138 200 344	VS1 Shelter 5m	315kg
138 200 345	VS1 Shelter 1m extension bay	
138 200 346	VS1 Shelter 2m extension bay	
138 200 347	VS1 Shelter 3m extension bay	
138 200 348	VS1 Shelter 4m extension bay	
138 200 349	VS1 Shelter 5m extension bay	

Product details

- Height – 2124mm front
- Width – 2090mm overall
- Length – 1m, 2m, 3m, 4m, 5m and extensions
- Square flange plate - 140mm x 140mm x 10mm
- Each flange plate requires 4 bolts
- 1mm galvanised sheet panels

Installation & use

This product is guaranteed for 12 months (if installed and used correctly)
 Each shelter leg requires bolting down to a suitable concrete surface, using expanding anchor bolts
 The area surrounding the installation must be flat and level with no nearby surface irregularities or gradient changes
 On-site assembly requires construction skill



www.autopa.co.uk
 +44 (0)1788 550556

AUTOPA Limited
 Cottage Leap, Rugby, Warwickshire CV21 3XP





VS1 Shelter Galvanised Steel Frame No Sides - Galvanised Sheet



2 x 1
138 200 340



2 x 2
138 200 341



2 x 3
138 200 342



2 x 4
138 200 343



2 x 5
138 200 344



www.autopa.co.uk
+44 (0)1788 550556

AUTOPA Limited
Cottage Leap, Rugby, Warwickshire CV21 3XP

